

Lumento C3

3-Channel Constant Current PWM Dimmer for LED Loads

ZDI-RGBCC3

Application programme version: [1.2]
User manual edition: [1.2]_a

CONTENTS

Contents	2
Document updates.....	3
1 Introduction	4
1.1 Lumento C3 / Lumento C4	4
1.2 Installation.....	5
1.3 RGB or RGBW Loads.....	7
2 Configuration	8
2.1 General Configuration.....	10
2.2 Channel.....	16
2.2.1 Main Configuration.....	16
2.2.2 Switch On/Off	20
2.2.3 Dimming.....	21
2.2.4 Status Objects	23
2.2.5 Colour Selection Objects (Only RGB / RGBW channels)	25
2.2.6 Custom On/Off.....	28
2.2.7 Timers	29
2.2.8 Scenes/Sequences	34
2.2.9 Lock.....	41
2.2.10 Custom Initialisation	42
Annex I. Communication Objects.....	44

DOCUMENT UPDATES

Version	Changes	Page(s)
[1.2]_a	Changes in the application program: <ul style="list-style-type: none">• Internal optimisation of the start-up process.	-

1 INTRODUCTION

1.1 LUMENTO C3 / LUMENTO C4

Lumento C3 and **Lumento C4** constitute the Zennio solution for light regulation in constant current LED luminaires (in contrast to the constant voltage LED luminaires controlled by **Lumento X3** and **Lumento X4**).

They provide, respectively, three and four independent output channels (up to 1000 mA each) and may be parameterised to work with different output configurations, according to the LED module type:

- **Individual channels:** allows an independent control over the different output channels.
- **RGBW** (Lumento C4) **or RGB** (Lumento C3): allows a joint control over one four-colour (Lumento C4) or one three-colour (Lumento C3) LED module, i.e., the output channel will be formed by the colour components (R, G, B or W, which stand for Red, Green, Blue and White respectively) of one single module, being all of them controlled jointly, but in a different proportion each.
- **RGB+W** (only Lumento C4): permits controlling a three-colour constant current LED module, plus an independent white channel (i.e., **an RGB channel** plus an **individual channel** for the connection of a white LED module).

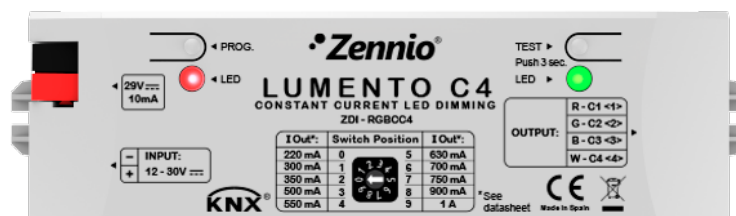

Figure 1. Lumento C4 Dimmer

IMPORTANT NOTE: *Lumento C3 does not incorporate a fourth channel (typically, W). Hereafter this manual may refer to such channel, but please keep in mind that it does not apply to the C3 model.*

1.2 INSTALLATION

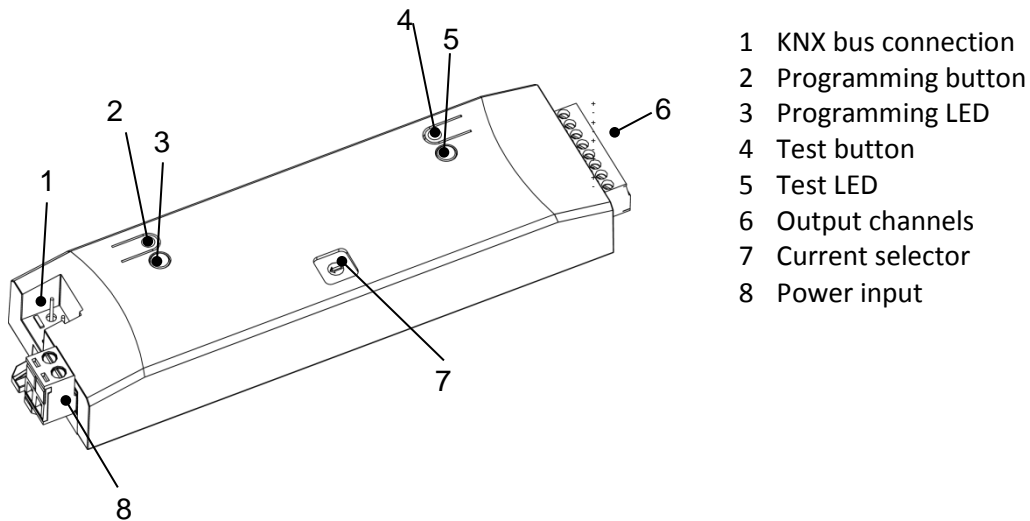

Figure 2. Connection scheme

The device connects to the KNX bus via the incorporated terminal (1), which provides the device with bus power. On the other hand, an **additional power supply** (12 to 30 VDC) is required for powering the LEDs. The external power supply is connected to the device through the corresponding screw terminal block included in the original packaging (8). The polarity of the external supply must be respected: the positive pole of the external power supply corresponds to the positive pole (+) of the terminal block, and analogously for the negative pole (-). If, for whatever reason, the connection of the power supply is carried out in the inverse way, Lumento C will report this **inverse polarity** through the Test indicator (5), which will turn orange.

Also provided with the device is a second screw terminal block, where **the LED modules** must be connected (6) respecting the polarity.

Note:

- *The output terminal block may be wired before it is inserted into the device.*
- **Only constant-current LED loads** can be connected to Lumento C.
- **Very important:** please respect the wiring schema shown on the output terminal block. Misconnecting the cables **may damage** the loads or Lumento C itself.

Once the device is provided with bus power, both the physical address and the application programme can be downloaded, even if no external power is being provided. The **absence of external power** is notified by the test LED (5) by flashing in orange.

The functionality of the main elements of the device is described below:

- **Programming button:** a short press on this button (2) sets the device into the programming mode, making the associated indicator (3) turns red. If this button is held while plugging the device into the KNX bus, the device will enter the **safe mode**, making the indicator blink in red.
- **Test button:** a long press on this button (4), of at least 3 seconds (until the associated indicator (5) lights in white) activates the Test Mode of the device, which allows verifying the correct connection of the LED modules.

Once the Test Mode is activated, **further short presses on the button will make the indicator change (Red-Green-Blue-White-Red...) and the output channels switch successively (1-2-3-4-1...)**. To leave the Test Mode, just press the Test button at least for 3 seconds (until the associated indicator switches off).

Note: *while the Test Mode is active, any order received from the KNX bus will be ignored until the deactivation of the mode.*

To obtain detailed information about the technical features of Lumento C3 and Lumento C4 as well as on security and on the installation process, please refer to the **Datasheet**, bundled within the original packaging of the device and also available at: www.zennio.com.

1.3 RGB OR RGBW LOADS

Lumento C3 and Lumento C4 are able to regulate the **colour** and the **luminosity level** of an RGB or RGBW diode module (the latter, only in Lumento C4).

In fact, both the colour and the luminosity are controlled by adjusting the level of the light emitted by the component colours (i.e., a change in the global luminosity is actually a joint adjustment of the luminosity of the component colours), however luminosity changes are performed by **maintaining the proportion between the components**, so in practice it is not the colour itself, but the light intensity, what is perceived to be changing.

LED modules are made of different colour components: Red, Green, Blue (RGB) and White (RGBW). The result of mixing the three first colours in the same proportion is, as well, the White colour, as shown in Figure 3. Other intermediate colours are obtained by combining the three main colours (R, G, B) or the four colours (R, G, B, W) in different proportions. The existence of a specific white component is normally intended to make these combinations easier and, generally, offers a higher fidelity when the white colour is shown.

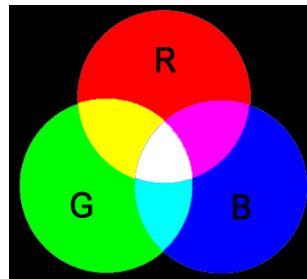

Figure 3. Combination of the Red, Green and Blue colour components

As stated, luminosity (or brightness) refers to the amount of light that the LED strip is emitting at a given time. The **general (or overall) brightness** of the set of diodes has been defined as the brightness of the **component that is emitting with the highest intensity**. On the other hand, the regulation of the general brightness is carried out so the visible colour is perceived as constant, by increasing or decreasing the brightness of the three colour components together, without losing their proportions.

Note: *the colour that is visually perceived (the colour actually obtained) may vary depending on the LED module and the colour diffuser being used.*

2 CONFIGURATION

Lumento C allows, as stated in the previous section, controlling the colour and the luminosity level of:

- **Up to four monochrome LED modules** (three in Lumento C3), or
- A **four-channel** RGBW LED module (a three-channel RGB LED module in Lumento C3), or
- A **three-channel** RGB LED module plus an **individual channel** for controlling the white colour independently (only in Lumento C4).

Some features and functions offered by this device are listed below:

- **Constant-current** (220 / 300 / 350 / 500 / 550 / 630 / 700 / 750 / 900 / 1000 mA, depending on the configuration) LED load control.
- **12V to 30V** input voltage for the LED load control.
- Wide range of alternatives for the LED module **colour control**, both for a **general** control and for a **per-channel** (R, G, B, W) control:
 - **1-bit** objects for a general and per-channel switch-on / switch-off.
 - **4-bit** objects for general and per-channel step dimming.
 - **1-byte** objects for general and per-channel absolute dimming (in percentage).
 - **3-byte** object for an RGB absolute dimming (in percentage).
 - **1-byte** scene object, with a number of pre-set colours.
 - **1-bit** object for colour scanning and selection.
- Four dimming times for each mode/channel: **At once**, **Dimming Time 1** / **Dimming Time 2** / **Dimming Time 3** (smooth dimming with configurable time).
- Restriction of the maximum allowed **light level**.

- **Custom ON/OFF:** possibility of enabling up to four different ON/OFF controls (or four per channel, in case of an independent channel control), with a specific colour, luminosity and dimming type for each case.
- **Simple Timer and Flashing:** timed ON/OFF sequences of the LED module.
- **Scenes/Sequences:** possibility of enabling from five to ten different scenes/sequences (depending on the mode), which can consist in a single **luminosity change** or a **custom sequence** (up to 5 customisable steps).
- **Lock:** object to lock/unlock the control over the LED module through bus orders.
- **Customisable Start-up:** possibility of performing a custom start-up (after a bus failure or an ETS download/reset) of the LED module connected to the device, as well as of sending the status objects to the KNX bus (immediately or after a delay).
- **Error identification:** detection of anomalous situations affecting the correct behaviour of the device:
 - External voltage errors.
 - Overheating errors.
 - Current selection error.

2.1 GENERAL CONFIGURATION

In the first place, it is necessary to define the **nominal current** of the LED loads to be controlled, as reported by the manufacturer. To prevent issues, this must be set both physically (**through the on-board hardware selector**) and **also in parameters**, making both selections match and comply with the manufacturer specification.

The correspondence between the position of the hardware selector and the associated nominal current is shown in the table below:

Position selector	Nominal current (mA)
0	220
1	300
2	350
3	500
4	550
5	630
6	700
7	750
8	900
9	1000

Table 1 Correspondence between the position selector and the nominal current.

Also within the general configuration, the integrator may enable the **objects for reporting errors** and set the **load type** to be controlled:

- **Individual channels:** three / four monochrome LED modules (one per output channel), which can be enabled, configured and controlled individually.
- **RGBW:** possibility of controlling jointly or individually the four components (R, G, B, W) of an RGBW module (in Lumento C4) or the three components (R, G, B) of an RGB module (in Lumento C3).
- **RGB+W** (only Lumento C4): similar to the above case, however the white channel here is always controlled independently.

ETS PARAMETERISATION

After importing the corresponding database in ETS and adding the device into the topology of the desired project, the configuration process begins by right-clicking into the device name and selecting *Edit parameters*.

Lumento C incorporates a set of functionalities, disabled by default, which can be selectively enabled depending on the installation requirements.

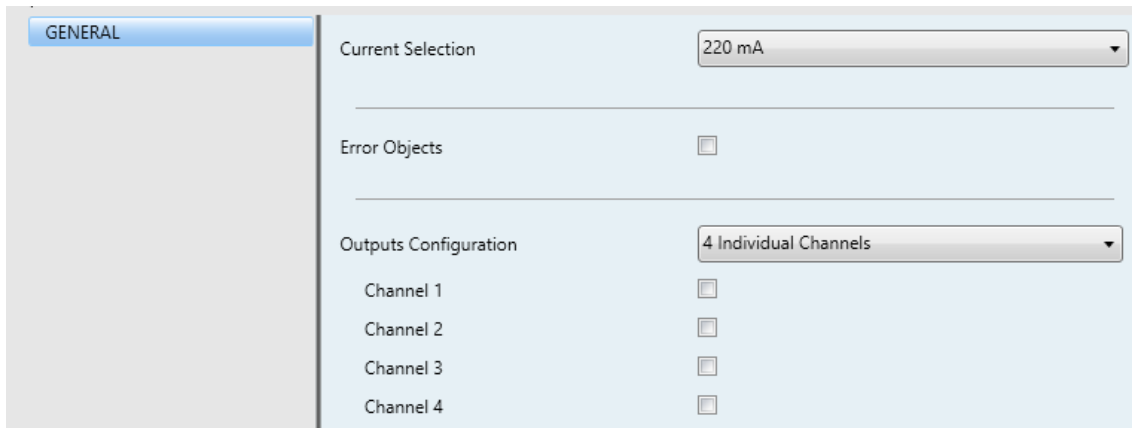

Figure 4 ETS Parameterisation. General.

Next, all the available functions are described, as well as their behaviour:

- **Current selection:** sets the nominal current of the LED loads connected to the output channels (see Table 1). The default value is “220 mA”, which corresponds to the position “0” of the current selector.

The value of this parameter **must match that of the current selector** located on the top of the device. Otherwise, the device will not regulate the loads, and the Test indicator will blink in white colour.

- **Error objects:** enables the following communication objects:
 - **“Error: Overheating”:** binary object that will report situations of an excessive system temperature (**higher than 75°C**) by sending the value “1” every 30 seconds. In such case, the light level of the output channels will be decreased and the Test indicator will start blinking in red colour.

If the system **reaches 80°C**, the outputs will be turned off and the Test indicator will remain turned on in red colour.

Once the temperature drops below 70°C, the value "0" will be sent through this object, although the outputs will remain off for safety reasons (however, they will respond to dimming orders).

Note: *even if the error notification objects have not been enabled in parameters, the overheating protection remains **always enabled**.*

- **"Error: Current Selector Mismatch"**: binary object through which the value "1" will be sent (every 30 seconds) in case the value of parameter **Current Selection** differs from that of the hardware selector. Once the mismatch is over, the device will send the value "0" through this object, although the outputs will remain off for safety reasons (however, they will respond to dimming orders).
- **"Error: External Voltage"**: binary object that will notify (by sending the value "1" every thirty seconds) an unexpected external power supply, due to any of these events:
 - Too low voltage.
 - Absence of power (disconnected source), which will make the Test indicator flash in orange colour.
 - Polarity inversion in the power supply, which will make the test indicator light in orange colour.

Once the situation is over, the value "0" will be sent, and the outputs will recover their previous states.

Table 2 shows a **summary of the different error types** and how the test LED indicator shows them.

Error	Colour	LED state
Current selection	White	Flashing
No external power supply	Orange	Flashing
Inversion in the polarity of the power supply	Orange	On
Overheating (75°C)	Red	Flashing
Overheating (80°C)	Red	On

Table 2. Error notification.

- **Outputs Configuration:** this device can be parameterized to control current LED loads of the following types: “Individual Channels” (by default), “RGBW” and “RGB+W”. In case of opting for the first option, it will be possible to selectively enable or disable each of the individual channels through the specific checkboxes (see Figure 4).

Depending on the option selected, one or more new tabs will be incorporated to the tab menu on the left, containing the configuration for the specific functions of each output channel.

➤ Individual Channels

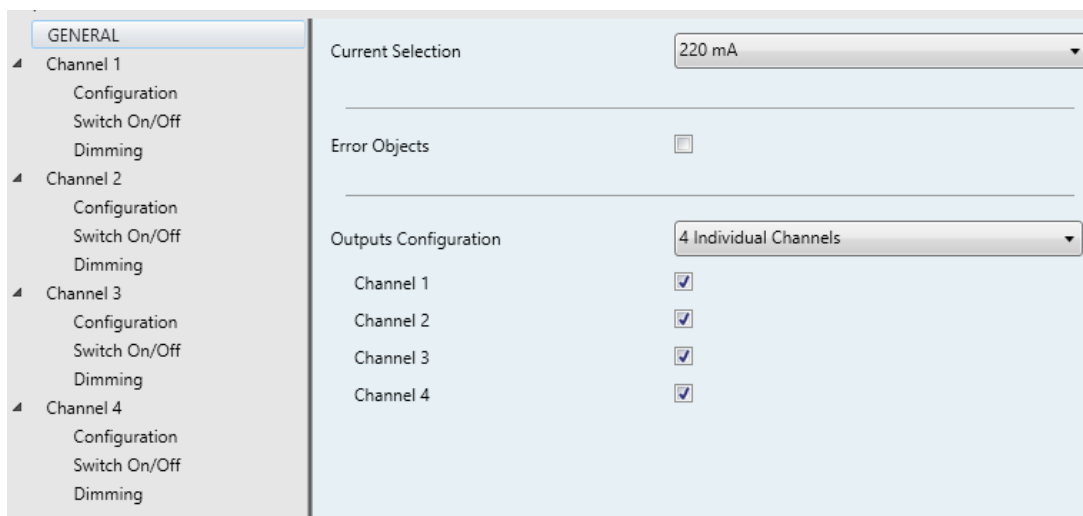

Figure 5. Channel configuration. Individual channels.

➤ RGBW (Lumento C4) / RGB (Lumento C3)

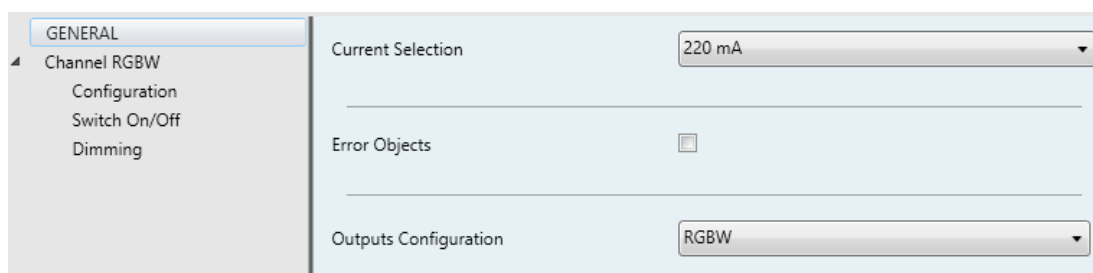

Figure 6. Channel configuration. RGBW.

➤ RGB+W (only Lumento C4)

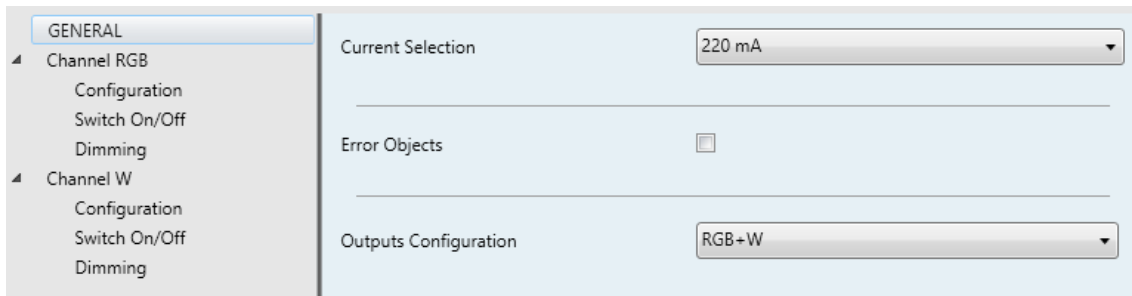

Figure 7. Channel configuration. RGB+W.

Note: hereafter, the prefix “[Ch]” will note objects referring to an output channel, although depending on the channel type the actual name will begin with “[1]”, “[2]”, “[3]”, “[4]”, “[RGBW]”, “[RGB]”, “[W]”, “[R]”, “[G]”, or “[B]”.

With independence of the channel type, **three control objects per channel** will be included in the project topology after the channel activation:

- “[Ch] **Switch On/Off**”: 1-bit object destined to perform a general switch-on (“1”) or switch-off (“0”) of the LED strip.
- “[Ch] **Relative Dimming**”: 4-bit object destined to step-dimming the general brightness (luminosity) level. Steps (upwards or downwards) of 1%, 3%, 6%, 12%, 25%, 50% and 100% are possible.
- “[Ch] **Absolute Dimming**”: one-byte object destined to specify a particular light level (by setting the target percentage value) over the general brightness level.

In the case of an RGBW, RGB or RGB+W control, an additional parameter (**Independent Control Objects**) will be provided to allow enabling specific control objects per each colour component in addition to the joint control objects for the whole channel.

Example

Assume that the outputs configuration is RGBW and the LED module colour at a given time is lime green [25%, 50%, 0%, 3%].

- A regulation order of '70%' is received through the object "**[RGBW] Absolute Dimming**". The component with the highest illumination level will be set to 70%, while the others will vary proportionally ($70 / 50 = 1.4$). Therefore, the output will become [35%, 70%, 0%, 4.2%].
- A regulation order to decrement the light level by 25% is received through the object "**[RGBW] Relative Dimming**". The component with the highest illumination level (G, with 70%) will decrease its value by 25% (becoming 45%), while the others will vary proportionally ($45 / 70 = 0.64$). Therefore, the output will become [35%, 70%, 0%, 4.2%].

The next sections detail the options contained by the channel-specific parameter tabs.

2.2 CHANNEL

Although it is possible to perform a per-component, or an RGBW / RGB, or an RGB+W control of the outputs, the functionality is analogous in all cases. The following sections describe this functionality, highlighting the details that differ from one case to another.

2.2.1 MAIN CONFIGURATION

The main configuration of the output channel covers the following options:

- **Economical Mode:** defines the maximum dimming value (in percentage from 50% to 100%) that can be applied to the channels through a dimming order. If this parameter is set to a value other than 100%, a proportional reduction of the luminosity will be applied. However, Lumento C4 will always send to the KNX bus luminosity values between 0% and 100%.

Example:

A value of 80% is assigned to this parameter. In such case, dimming orders for a luminosity of 100% will actually set a luminosity of 80%, although the status object will show the value 100%. Analogously, orders for a luminosity of 50% will actually set it at 40%, although the status object will show 50%.

- **Dimming times:** the dimming time is the length of the transition between off (0%) and the maximum luminosity level (100%), and therefore determines the speed of the regulation. **Up to three different dimming times** can be applied to the different orders or actions, and their values may be changed through three communication objects (one per each dimming time).

Note: *since the dimming time refers to the transition from the minimum luminosity level (off) to the maximum luminosity level, enabling the economical mode will increase the dimming speed, as the maximum luminosity level becomes lower but must be reached in the same (parameterised) time.*

- **Independent Control Objects** (RGBW / RGB / RGB+W only): brings the option to control each of the colour components individually (in addition to the joint control) analogously as in the individual channel output configuration.
- **Functions**: it is possible to configure a set of custom functions per channel:
 - **Enable / Disable Status Objects**: shows or hides the status objects associated to the channel (On/Off status and dimming status). See section 2.2.4.
 - **Colour Selection Objects** (RGBW / RGB / RGB+W only): enables or disables the objects for the selection and control of the resulting colour, either through a direct selection, or by assigning values to the colour components or through a colour shift sequence. See section 2.2.5.
 - **Custom On/Off**: allows enabling up to four custom On/Off controls, with different dimming values and times. See section 2.2.6.
 - **Timers**: defines timed or delayed on/off switches. See section 2.2.7.
 - **Scenes and sequences**: enables the configuration of custom dimming sequences and scenes. See section 2.2.8.
 - **Lock**: allows locking the output channel, i.e., disable the control. See section 2.2.9.
 - **Custom initialisation**: customises the initial state of the loads connected to the output. See section 2.2.10.

ETS PARAMETERISATION

After setting the output control type, one or more channel tabs will be displayed, as shown in Figure 8. The two highlighted parameters are only available under an RGB, RGBW or RGB+W output control.

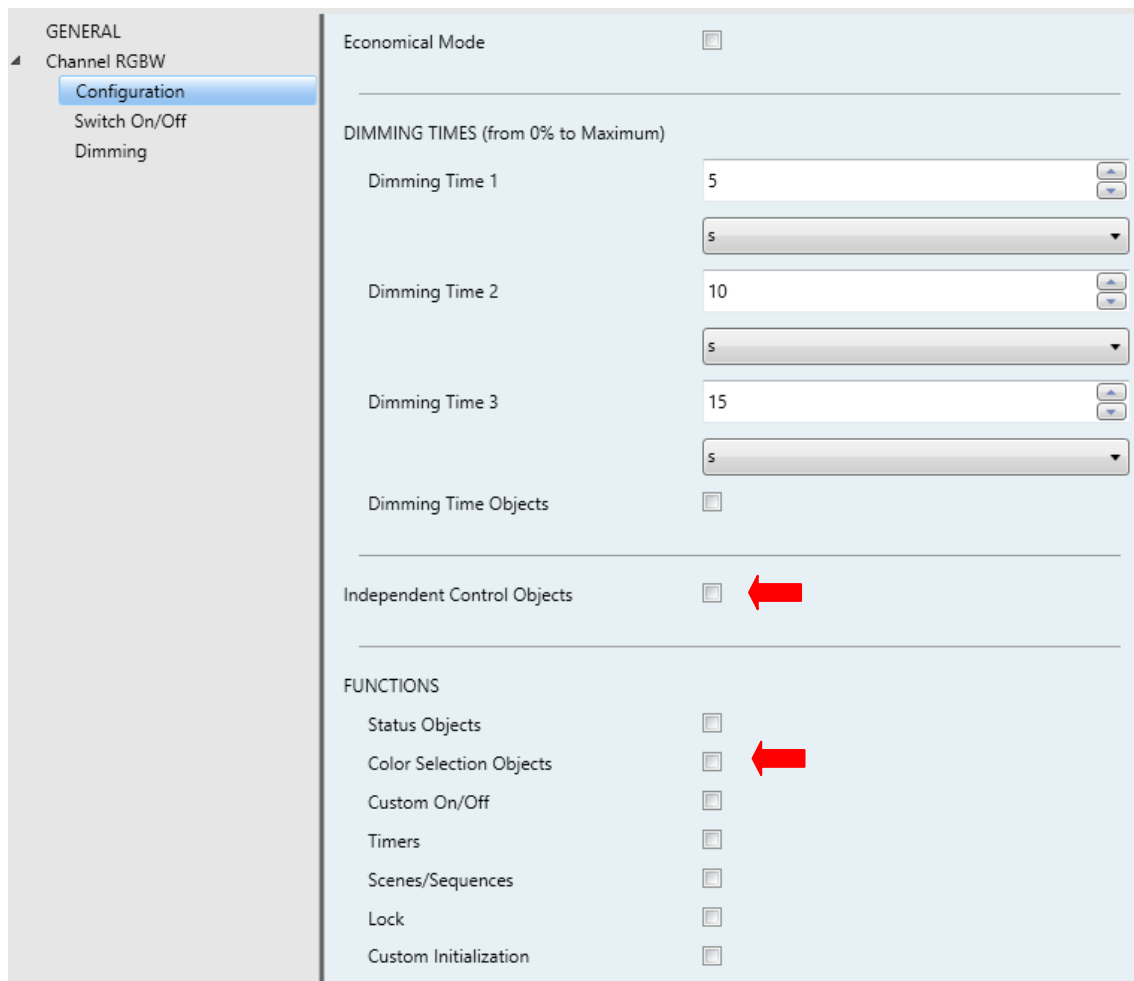

Figure 8. Channel X. Configuration.

This screen includes the following parameters:

- **Economical Mode:** this parameter can be “Enabled” or “Disabled” (by default). When enabled a new parameter shows up:

- **Maximum Light Level:** sets the maximum percentage dimming value that the channel can reach. Allowed values from “50%” to “100%” (by default).

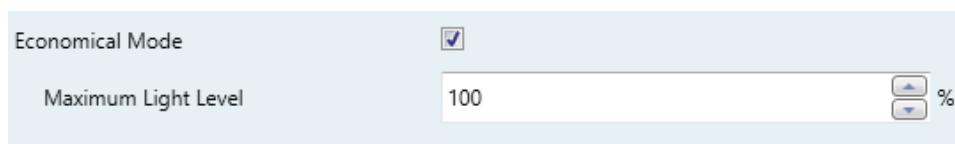

Figure 9. Channel X. Configuration. Economical Mode.

- **Dimming Times:** length of the transition between luminosity levels “0%” and “100%”. Three dimming times may be parameterised, through the following parameters:

- **Dimming Time [n]**: sets the dimming time n (1-3) duration. Allowed values are 1 to 100 (tenths of a second, seconds or minutes).
- **Dimming Time Objects**: enables three two-byte objects, named “[Ch] Dimming Time n ”, which allow changing the dimming times parameterised (up to 6000 seconds). This parameter is disabled by default.
- **Independent Control Objects (RGBW / RGB / RGB+W only)**: enables additional communication objects per colour components, analogous to those in an individual channel control. These objects are:
 - “[X] Switch On/Off”: one-bit object for a switch-on (“1”) or a switch-off (“0”) of component X.
 - “[X] Relative dimming”: four-bit object destined to step-dimming the luminosity level of component X. Steps upwards or downwards (of 1%, 3%, 6%, 12%, 25%, 50% or 100%) are possible.
 - “[X] Absolute dimming”: one-byte object destined to specify a particular light level (by setting the target percentage value) over the brightness level of component X.

Note: [X] notes [R], [G], [B] or [W].

- **Functions**: checkboxes to enable or disable certain functionalities of the channel (when enabled, new tabs or objects are added to the project):
 - **Status Objects**: see section 2.2.4.
 - **Colour Selection Objects**: see section 2.2.5.
 - **Custom On/Off**: see section 2.2.6.
 - **Timers**: see section 2.2.7.
 - **Scenes / Sequences**: see section 2.2.8.
 - **Lock**: see section 2.2.9.
 - **Custom initialization**: see section 2.2.10.

2.2.2 SWITCH ON/OFF

Lumento C lets configuring the general On/Off switch control, so that these actions are performed **immediately** or through a **smooth regulation** (according to one of the three configurable dimming times; see section 2.1).

Furthermore, it is possible to specify the illumination level that the channel will adopt when a general switch-on order is executed: either a **fixed value** (configurable in parameters) or the **last value** prior to the switch off (i.e., a memory switch-on).

Note that, in RGB / RGBW channels, **the colour will always be preserved** when the channel is switched off and afterwards on. Configuring a specific illumination level only affects to the light intensity, not to the ratio of the different colour components.

ETS PARAMETERISATION

The “Switch On/Off” window, available from the start, contains the following parameters.

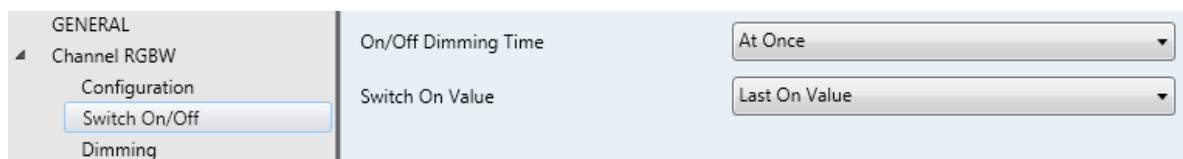

Figure 10. Switch On/Off

- **On/Off Dimming Time:** “At Once”, “Dimming Time 1”, “Dimming Time 2”, “Dimming Time 3”. See section 2.2.1.
- **Switch On Value:** allows selecting the general illumination level that will be adopted by the channel when the value “1” is received through “[Ch] Switch On/Off”: “Last On Value” (default option) or “Defined Value”. The latter brings an additional parameter:
 - **Defined Value:** sets the desired illumination level, between 0% and 100%. The default option is 100%.

Example:

“Last On Value” is selected with an RGB channel configuration.

- The LED module is on, and in orange colour (100%, 20%, 0%). If '1' is received through “[RGB] Switch On/Off”, it will remain in the same state.
- The channel is switched off by sending one '0' through “[RGB] Switch On/Off”. If afterwards the value '1' is received through the same object, the channel will show orange colour again.
- A “Decrement by 50%” relative dimming order is sent through “[RGB] Relative Dimming”, so the channel switches to (50%, 10%, 0%). Afterwards, an identical order is sent again, causing the switch-off of the channel. If it is eventually switched on through “[RGB] Switch On/Off”, the orange colour will be restored at level (50%, 10%, 0%).

On the contrary, under a “Defined Value” configuration (with value 80%):

- The channel module is on, and in orange colour (100%, 20%, 0%).
- A “Decrement by 50%” relative regulation order is sent through “[RGB] Relative Dimming”. The colour ratio is preserved, reducing the illumination level to (50%, 10%, 0%). Afterwards, the channel is switched off.
- When a '1' is received through “[RGB] Switch On/Off”, the illumination level is set to 80% but preserving the colour ratio, which results in (80%, 16%, 0%).

2.2.3 DIMMING

Lumento C4 provides two general dimming modes besides the general On/Off:

- **Relative Dimming:** modifies the luminosity level through orders to increment or decrement it by fixed percentages (“1.6%”, “3.1%”, “6.3%”, “12.5%”, “25%”, “50%” or “100%”), which will be added to or subtracted from the current luminosity level of the channel. A **four-bit object** is provided for the reception of the relative dimming orders.
- **Absolute dimming:** modifies the luminosity level through orders that specify the desired target value, regardless of the current value of the channel. A

one-byte object is provided for the reception of the absolute dimming orders.

Both regulation modes will be subject to the **maximum and minimum illumination levels specified in parameters** (which may be helpful depending on the response of the LED loads). It is also possible to configure **which of the three already-defined dimming times should apply to perform the entire transition** between 0% and 100% (i.e., the dimming speed), unless an immediate transition is preferred.

ETS PARAMETERISATION

The “Dimming” window, available from the start, contains the following parameters:

Figure 11. Dimming

- **RELATIVE DIMMING (4 bits):** this section allows setting up the configuration of the relative dimming function and the **four-bit** object “[Ch] Relative Dimming”.
 - **Relative Dimming Time:** “At Once”, “Dimming Time 1”, “Dimming Time 2”, “Dimming Time 3”. See section 2.2.1. The default value for this parameter is “Dimming Time 1”.
 - **Maximum Dimming Value:** sets the maximum illumination percentage (between “51%” and “100%”) that will be allowed in the channel. If an order implying an illumination level beyond this limit is received, the channel will adopt this maximum level, as the status object will reflect

- **Minimum Dimming Value:** sets the minimum illumination percentage (between “0%” and “50%”) that will be allowed in the channel. If an order implying an illumination level below this limit is received, the channel will adopt this minimum level (unless “**Allow Switching Off via Relative Dimming**” is active; see below), as the status object will reflect.
 - **Allow Switching On via Relative Dimming:** sets whether Lumento C should switch on the channel in case a light increase order is received and the channel is found to be off, or simply ignore the order.
 - **Allow Switching Off via Relative Dimming:** sets whether Lumento C should switch off the channel in case the channel is found to be on and a light decrease order is received implying a luminosity value of 0% (or of any other value below the minimum dimming value parameterised), or simply ignore the order.
- **ABSOLUTE DIMMING (1 byte):** this section allows setting up the configuration of the relative dimming function and the **one-byte** object “[Ch] **Absolute Dimming**”. All parameters are analogous to those for the relative dimming.

2.2.4 STATUS OBJECTS

Lumento C provides different objects that report the current illumination state of the output channel:

- **A one-bit object** (On/Off),
- **A one-byte object**, which indicates the illumination level (in percentage),
- **A three-byte object** (in the case of an RGB, RGBW or RGB+W configuration), which indicates the illumination level (in percentage) of the three main colour components.
- **Independent status objects** (in the case of an RGB, RGBW or RGB+W configuration), i.e.:
 - A one-bit object (On/Off) per colour component.
 - A percentage one-byte object per colour component.

ETS PARAMETERISATION

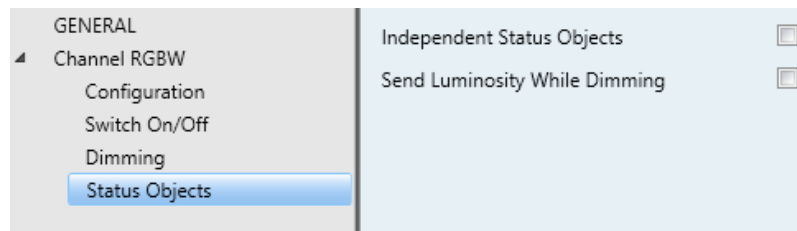

Figure 12. Status Objects

The activation of this function brings in a new tab to the channel configuration within the side menu, as well as the following **communication objects**:

- “[Ch] On/Off (Status)”: one-bit object that indicates if the channel is switched off (“0”) or on (“1”).
- “[Ch] Dimming Value (Status)”: one-byte object that represents the illumination percentage of the channel (0% to 100%).

Note: *under RGB, RGBW and RGB+W output configurations, this general illumination level will always refer to that of the colour component (R, G, B or W) with the maximum illumination level at the moment.*

- “[Ch] RGB Dimming Values (Status)” (RGBW / RGB / RGB+W only): three-byte object which indicates the illumination levels of the three main colour components. Each byte represents, respectively, the R, G and B components.

Regarding the parameters contained in the Status Objects tab:

- **Independent Status Objects** (RGBW / RGB / RGB+W only): “Disabled” by default, its activation will enable two additional status objects for each single channel (R, G, B, W):
 - “[X] On/Off (Status)”: one-bit object that indicates if the component is switched off (“0”) or on (“1”).
 - “[X] Dimming Value (Status)”: **1-byte**: one-byte object that represents the illumination percentage of the component (0% to 100%).

- **Send Luminosity While Dimming:** makes the “[Ch] Dimming Value (Status)” object be sent periodically to the bus throughout the dimming process. If enabled, also the following parameter will appear:
 - **Sending Period (with Value Change):** defines the sending cycle time (1 to 100 seconds) of the status object.

Notes:

- *The status object is sent unless its value has not changed since the previous sending.*
- *Under an RGB / RGBW / RGB+W configuration, “[Ch] RGB Dimming Values” will be sent as well together with the “[X] Dimming Value (Status)” individual status objects, if enabled.*
- *As soon as the channel illumination level is greater than 0%, the “[Ch] On/Off (Status)” object will be sent with the value “1”, while the value “0” will be sent as soon as it becomes 0% again. The per-component “[X] On/Off (Status)” objects, if enabled, will behave analogously.*

2.2.5 COLOUR SELECTION OBJECTS (ONLY RGB / RGBW CHANNELS)

For RGB, RGBW and RGB+W configurations, Lumento C provides different procedures for selecting the desired joint colour:

- **Through a three-byte object** that sets the illumination level (in percentage) of the main colour components (R, G and B).
- **By triggering a colour scan**, which will start from the nearest stage among those shown in the figure below, and may be interrupted once the desired colour is reached.

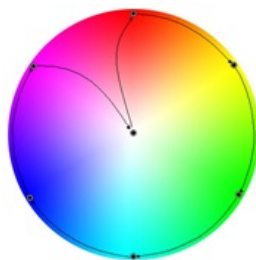

Figure 13. Colour Scan

- **Though a one-byte direct colour object**, which permits selecting (by sending an integer value between 0 and 21) any of the following twenty-two pre-set colours:

Scene (Value)	Colour	R	G	B	W
1 (0)	Off	0	0	0	0
2 (1)	White	0	0	0	255
3 (2)	White – Light	128	128	128	128
4 (3)	Blue	0	0	255	0
5 (4)	Blue – Light	102	204	255	51
6 (5)	Blue – Navy	0	0	102	0
7 (6)	Blue – Cyan	0	255	255	0
8 (7)	Blue – Turquoise	0	255	77	51
9 (8)	Blue – Lavender	128	128	255	51
10 (9)	Green	0	255	0	0
11 (10)	Green – Light	128	255	51	51
12 (11)	Green – Dark	0	102	0	0
13 (12)	Green – Lime	128	255	0	13
14 (13)	Red	255	0	0	0
15 (14)	Red – Pink	255	0	77	0
16 (15)	Red – Dark	102	0	0	0
17 (16)	Red – Magenta	255	0	255	0
18 (17)	Red – Fuchsia	255	26	51	0
19 (18)	Yellow	255	255	0	0
20 (19)	Orange	255	51	0	0
21 (20)	Lilac	255	128	128	0
22 (21)	Purple	170	0	255	0



Table 3. Pre-set Direct Colours

ETS PARAMETERISATION

Enabling the **Colour Selection Objects** parameter (disabled by default) will enable as well the following communication objects:

- “[Ch] RGB Colour”: three-byte object which allows setting the luminosity of each component (between 0 and 255). Thus, the first byte represents the red channel (R) illumination, while the second byte represents that of the green channel (G) and the third one refers to the blue channel (B).
- “[Ch] Direct Colour”: one-byte object for choosing one of the 22 pre-set colours (Table 3).

- “[Ch] Colour Shift”: two homologous objects of one-bit and four-bit size, respectively, to start or stop the colour scan function.
 - The **one-bit** object is destined to combine this functionality with a simple, binary control.
 - The **four-bit** object allows integrating this functionality into light-dimming one-button controls: orders to increase the light level will trigger a forward colour scan, while orders to decrease the light level will trigger a backward colour scan. Table 4 shows the length of the scan depending on the step order received (note that the entire scan takes place in any of the cases).

Increase/Decrease	Period (s)
100%	30
50%	25
25%	20
12.5%	15
6.25%	12
3.12%	7
1.5%	4
Stop	Interrupt scan

Table 4. Scan length depending on the step order received

Example:

Suppose a one-button control of type “Dimming Control (Toggle)” on the **TMD Plus** from Zennio. If it has been assigned a dimming step of 25% and the communication objects (including the status objects) have been properly linked to those in Lumento C:

- Being the LED module off, when the user performs a long press on the button, TMD Plus sends an order to increase by 25%. The LED module switches on and the colour scan begins, with a 20 second period.
- When the user releases the button TMD Plus sends an order stop, so the colour shift is interrupted. From that moment on, the user may perform further long presses to start over the colour scan, or a short press to switch off the module.

2.2.6 CUSTOM ON/OFF

This function offers up to four additional On/Off controls for the output channel, and therefore up to four new communication objects to switch the load on and off.

These additional controls may be customised with specific illumination levels for the “on” and “off” states, and may also be configured to perform an immediate or soft dimming.

ETS PARAMETERISATION

Once enabled, the following parameters will show in ETS:

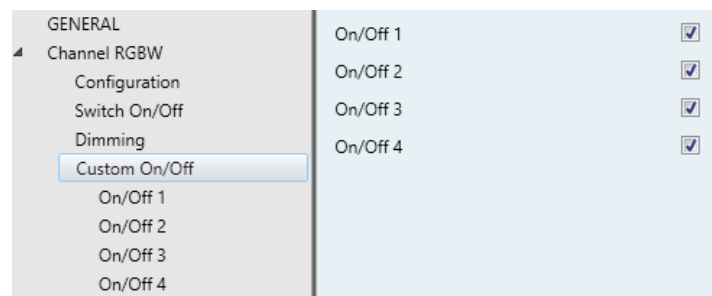

Figure 14. Custom On/Off

- **On/Off ‘n’:** “Disabled” by default. Once enabled, the “[Ch] Custom On/Off ‘n’” one-bit object and a specific parameter tab will show in ETS:

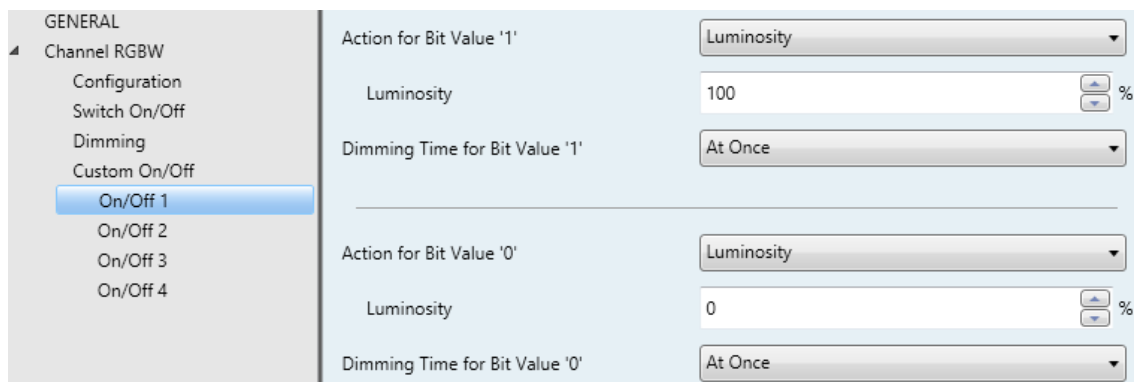

Figure 15. Custom On/Off (detail)

This screen allows setting up the specific behaviour when a “1” or a “0” are received through object “[Ch] Custom On/Off ‘n’”:

- **Action for Bit Value '1'**: (only RGB / RGBW channels): sets the action to perform when a "1" is received through "[C] Custom On/Off 'n'". One of the following actions may be chosen:
 - "Luminosity" (default): sets a specific illumination percentage (0% to 100%) to be applied to the channel when a "1" is received.
 - "Predefined Colour": permits selecting one of the pre-set colours (see Table 3).
 - "RGB/RGBW Colour": sets a specific luminosity value (0 to 255) for each of the colour components.

- **Dimming Value for Bit Value '1'** (only individual channels and white channel): equivalent to the above "Luminosity" option, although only applies to a specific individual channel.

- **Dimming Time for Bit Value '1'**: "At Once", "Dimming Time 1", "Dimming Time 2", "Dimming Time 3". Allows selecting the dimming type (in terms of speed) which will be applied to the transition from current level to that set in the previous parameter. See section 2.2.1.

- **Action for Bit Value '0'**: analogous to the above **Action for Bit Value '1'**, but referred to the arrival of the value "0" from the bus.

- **Dimming Value for Bit Value '0'**: analogous to the above **Dimming Value for Bit Value '1'**, but referred to the arrival of the value "0" from the bus.

- **Dimming Time for Bit Value '0'**: analogous to the above **Dimming Time for Bit Value '1'**, but referred to the arrival of the value "0" from the bus.

2.2.7 TIMERS

This function allows configuring a **simple timing** and a **flashing sequence** in the output channel, being it possible to enable or disable both functions independently.

The **simple timing** function consists in a switch-on of the channel (with an optional delay) on the reception of the corresponding trigger object, and a later switch-off, either automatic (after a certain period) or triggered through the corresponding bus object, also with an optional delay in this case.

On the other hand, the **flashing** function consists in switching the channel on and off a certain number of times or indefinitely, according to the parameters, once the corresponding object is received.

ETS PARAMETERISATION

Once enabled, the following parameters will show in ETS:

- **SIMPLE TIMER:** checkbox to enable or disable the simple timer function, as well as its specific parameters and the “[Ch] Simple Timer” one-bit object, which will trigger a delayed switch-on when the value “1” is received, and a delayed switch-off when the received value is “0”.

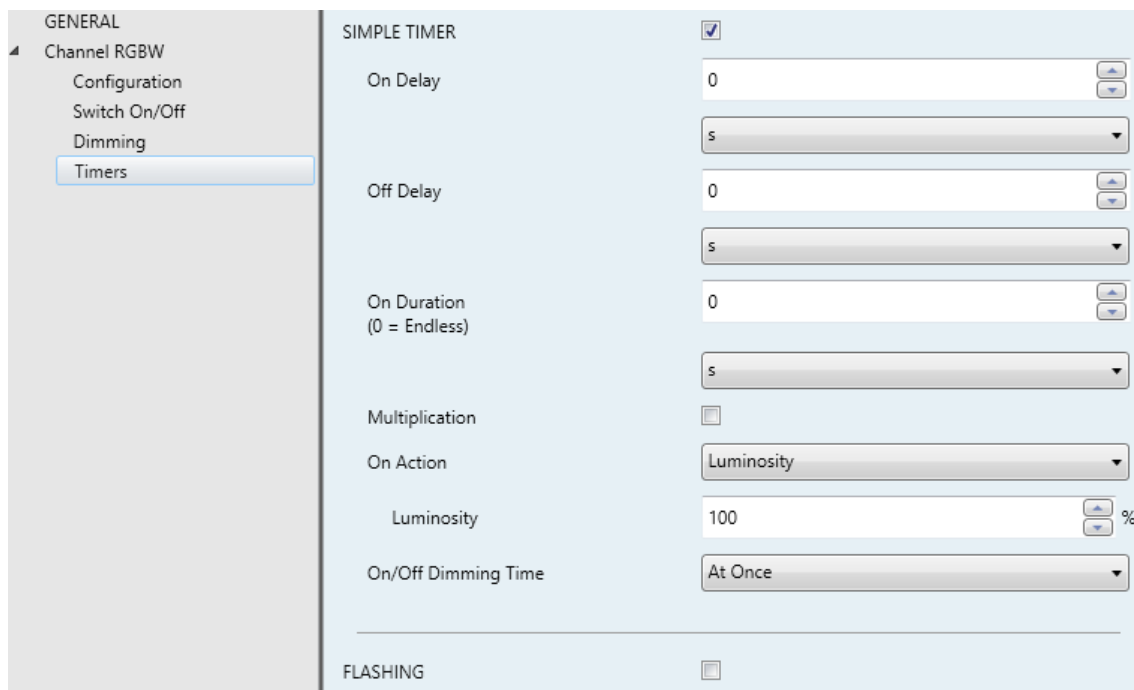

Figure 16. Simple Timer

- **On Delay:** sets a delay between the reception of the simple timer trigger order (value “1” through object “[Ch] Simple Timer”) and the actual switch-on of the channel, in the range 0 to 100 tenths of a second, seconds or minutes.
- **Off Delay:** sets a delay between the reception of the simple timer stop order (value “0” through object “[Ch] Simple Timer”) and the actual switch-off of the channel, in the range 0 to 100 tenths of a second, seconds or minutes.

- **On Duration:** sets the time the output channel must remain on before being automatically switched off (unless a simple timer stop order is received), in the range 0 to 100 tenths of a second, seconds or minutes. The value “0” (default option) will disable the automatic switch-off, thus making the simple timer switch-on state endless.
- **Multiplication:** enables the Multiplication function, so the successive reception of the value “1” through “[Ch] Simple Timer” will multiply the On Duration time as many times as it is received. This process will be taken into consideration up to five times. If this parameter is left disabled, receiving the value “1” several times will only restart the On Duration count.

Example:

<i>On Delay:</i>	2 s
<i>Off Delay:</i>	4 s
<i>On Duration:</i>	6 s
<i>On Value:</i>	100%
<i>On/Off Dimming Time:</i>	At Once.

Multiplication disabled

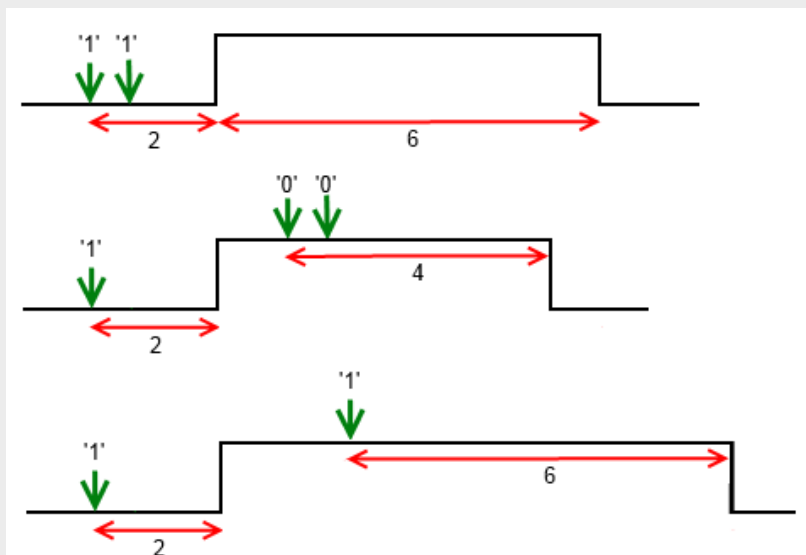

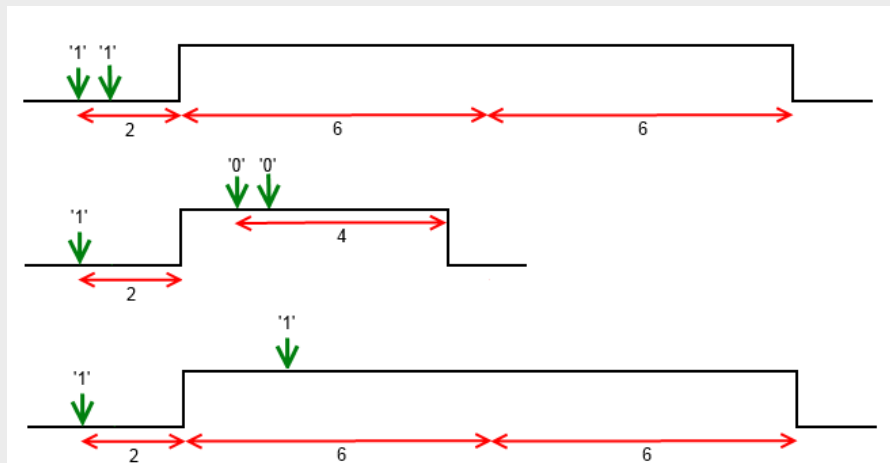
Multiplication enabled

- **On Action** (only RGB / RGBW channels): sets the action to be performed when the value “1” is received through “[Ch] Simple Timer”: “Luminosity”, “Predefined Colour” and “RGB/RGBW Colour” (analogously as in section 2.2.6).
- **On Value** (only individual or W channels): analogous to choosing “Luminosity” in the previous parameter (**On Action**).
- **On/Off Dimming Time**: “At Once”, “Dimming Time 1”, “Dimming Time 2”, “Dimming Time 3” (see “Dimming times” in section 2.2.1).

Note: *the simple timer function will be interrupted whenever any other dimming action is commanded, no matter if it falls within the On Duration or during the on / off delays.*

- **FLASHING**: checkbox to enable or disable the flashing function, as well as its specific parameters and the “[Ch] Flashing” one-bit object, which will trigger an On-Off-On... sequence when the value “1” is received, and will interrupt it

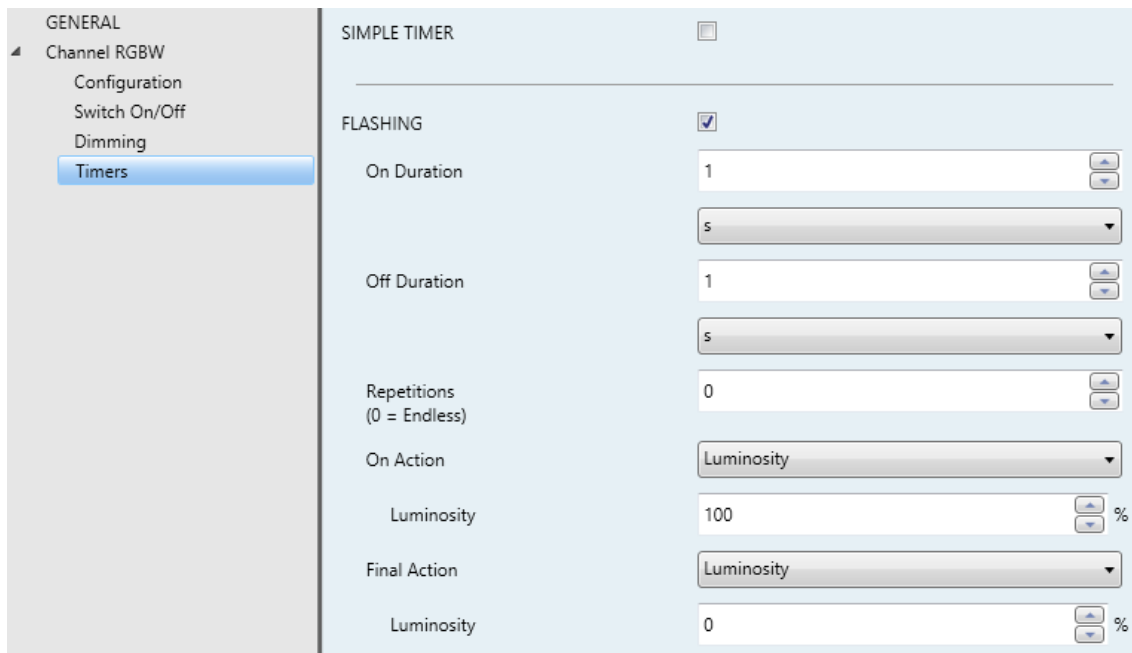

Figure 17. Flashing

- **On Duration:** sets the length of each “On” stage during the sequence, in the range 1 to 100 tenths of a second, seconds or minutes.
- **Of Duration:** sets the length of each “Off” stage during the sequence, in the range 1 to 100 tenths of a second, seconds or minutes
- **Repetitions:** sets the number of iterations of the sequence, between 0 and 255. The value “0” (default option) causes an endless repetition, until an order to interrupt the sequence is received.
- **On Action** (only RGB / RGBW channels): sets the action to be performed during the “On” stages of the sequence: “Luminosity”, “Predefined Colour” and “RGB/RGBW Colour” (analogously as in section 2.2.6).
- **On Value** (only individual or W channels): analogous to choosing “Luminosity” in the previous parameter (**On Action**).
- **Final Action** (only RGB / RGBW channels): sets the action to be performed after the last iteration of the sequence, as well as when the value “0” is received through “[Ch] Flashing”: “Luminosity”, “Predefined Colour” and “RGB/RGBW Colour” (analogously as in section 2.2.6).

- **Final Value** (only individual or W channels): analogous to choosing “Luminosity” in the previous parameter (**Final Action**)

2.2.8 SCENES/SEQUENCES

This feature allows defining different scenes, i.e., specific ambiences or dimming sequences, which may be activated by sending the corresponding trigger value to the **on-byte scenes / sequences objects**.

Lumento C offers **up to five** scenes / sequences per each individual or white channel and **up to ten** scenes / sequences per RGB or RGBW channel.

ETS PARAMETERISATION

Once this function has been enabled, the following objects will show in ETS:

- “[Cx] **Scenes/Sequences**”: triggers the scene or sequence whose number corresponds to the value received through the object (see below).
- “[Cx] **Start/Stop Sequence**” (one bit): allows to start the last sequence performed, or re-start the one currently in execution (sending the value “1”), as well as interrupting the current sequence (value “0”).

Note: the “[Cx] **Start/Stop Sequence**” object only applies to sequences, and has no effect over static scenes. Moreover, after a download from ETS (partial or complete), if the value “1” is sent through this object, Lumento C will trigger the first, non-static sequence parameterised.

The “Scenes/Sequences” tab in ETS contains the following parameters:

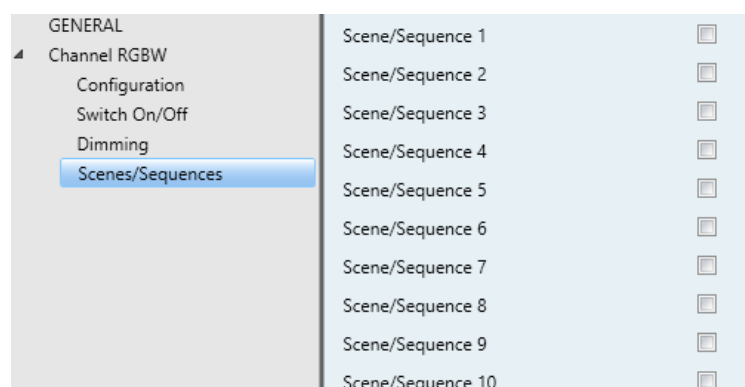

Figure 18. Scenes/Sequences

Each scene / sequence activated from this screen will have a specific tab associated, labelled as “**Scene/Sequence ‘n’**” and containing the following parameters:

GENERAL	Scene/Sequence Number [1 to 64]	1
Channel RGBW	Scene/Sequence Type	Luminosity
Configuration	Luminosity	100 %
Switch On/Off	Dimming Type	At Once
Dimming		
Scenes/Sequences		
Scene/Sequence 1		

Figure 19. Scene configuration

The following parameters are available:

- **Scene/Sequence Number:** sets the scene/sequence identifying number (from 1 to 64) whose reception (decreased by 1, according to the KNX standard) through the “[Ch] Scenes/Sequences” object will make the device trigger the scene/sequence.
- **Scene/Sequence Type:** selects the desired action on the activation of the scene/sequence:
 - “Luminosity” (only RGB / RGBW channels): the scene activation will consist in setting a fixed illumination value (0% to 100%) in the channel.

The following parameters will show up:

- **Luminosity:** sets the desired illumination level percentage.
- **Dimming Type:** “At Once”, “Dimming Time 1”, “Dimming Time 2”, “Dimming Time 3”. See section 2.2.1.

In this case it will be also possible to **save scenes**. If a scene saving order (values 128 to 191) is received, the current luminosity level of the channel will be taken into account for later triggers of the corresponding scene.

- “Predefined Colour” (only RGB / RGBW channels): the execution of the scene will consist in setting a specific pre-set colour. See Table 3.

This option also entails the following parameters:

- **Predefined Colour:** sets the desired colour.

- **Dimming Type:** “At Once”, “Dimming Time 1”, “Dimming Time 2”, “Dimming Time 3”. See section 2.2.1.
- “RGB Colour/ RGBW Colour” (only RGB / RGBW channels): the execution of the scene will consist in setting fixed values to the R, G, B and W (if existing) colour components. The following parameter will also be available:
 - **Dimming Type:** “At Once”, “Dimming Time 1”, “Dimming Time 2”, “Dimming Time 3”. See section 2.2.1.
- “Fixed Value” (only individual or W channels): the scene activation will consist in setting a fixed illumination value (0% to 100%) in the channel.
- “Predefined Sequence” (only RGB / RGBW channels): the execution of the scene will consist in a predefined colour sequence, configurable through the following parameters::
 - **Predefined Sequence:** “Colourful” (default), “Cool Colours”, “Warm Colours”, “Sunrise”, “Sunset” or “TV/Presence Simulation”. The specific colour transition of each sequence is listed below.

“**Colourful**” (cyclic sequence).

Step#	Colour	RGBW	Period
1	Red	255/0/0/0	t/5
2	Green	0/255/0/0	t/5
3	Blue	0/0/255/0	t/5
4	Magenta	255/0/255/0	t/5
5	Yellow	255/255/0/0	t/5



“**Cool colours**” (cyclic sequence).

Step#	Colour	RGBW	Period
1	Blue 1	100/128/255/0	t/5
2	Green 1	20/255/100/0	t/5
3	Green	0/255/0/0	t/5
4	Green 2	0/255/77/0	t/5
5	Blue	0/0/255/0	t/5



“Warm colours” (cyclic sequence).

Step#	Colour	RGBW	Period
1	Red	255/0/0/0	t/5
2	Magenta	255/0/255/0	t/5
3	Pink	255/0/77/0	t/5
4	Orange	255/51/0/0	t/5
5	Yellow	255/255/0/0	t/5



“Sunrise” (non-cyclical sequence; executed only once, performs a colour transition from darker to brighter colours, which will depend on the Final Luminosity parameterised)

Step#	Colour	RGBW	Luminosity	Period
1	Switched Off	0/0/0/0	0%	0
2	Red	63/0/0/0	25%	t/4
3	Orange	128/25/0/0	50%	t/4
4	Yellow	191/191/0/0	75%	t/4
5	White	255/255/255/0	100%	t/4



“Sunset” (non-cyclical sequence; executed only once, performs a colour transition from brighter to darker colours, which will depend on the Final Luminosity parameterised).

Step#	Colour	RGB/RGBW	Luminosity	Period
1	White	255/255/255/0	100%	0
2	Yellow	191/191/0/0	75%	t/4
3	Orange	128/25/0/0	50%	t/4
4	Red	63/0/0/0	25%	t/4
5	Switched Off	0/0/0/0	0%	t/4



“TV/Presence Simulation” (sequence showing random colours and times; the colour transitions are immediate).

- **Time** (not available for “TV/Presence Simulation”): sets the length of a full cycle of the sequence, between 1 and 100 minutes.
- **Luminosity** (not available for “Sunset” or “Sunrise”): sets the luminosity that will be applied along the sequence execution, between “0%” and “100%”.

- **Final Luminosity** (“Sunrise” only): sets the luminosity to be applied at the end of the sequence, between 0% and 100%.
- **Initial Luminosity.** (“Sunset” only): sets the luminosity to be applied at the beginning of the sequence, between 0% and 100%.
- **Send Luminosity During the Sequence:** enables or disables a periodic sending of the status object while the sequence is running.

Note: *this option will not be available unless parameter **Send Luminosity While Dimming** has been activated (see section 2.2.2). The sending period will be in accordance to the one configured there.*

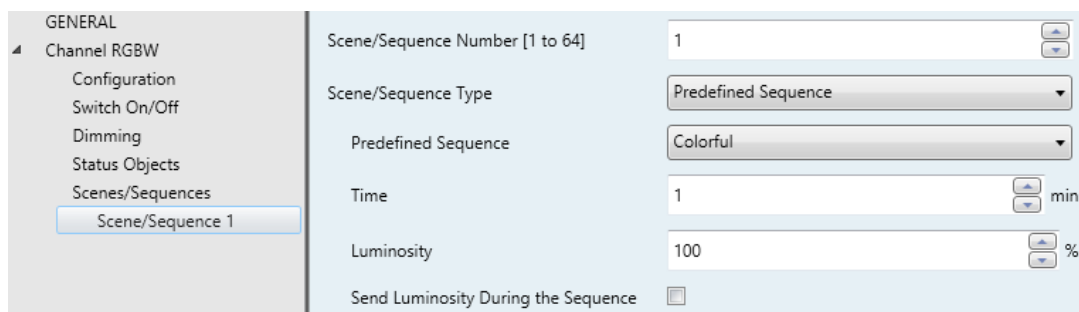

Figure 20. Pre-defined sequence

- **“Custom Sequence”:** brings the option to define sequences **up to five steps**, and to configure the following parameters:
 - **Cyclic:** “Enabled” (after the last step, the sequence will start over) or “Disabled” (default option; in such case, after the last step, it will be possible to automatically trigger any other sequence parameterised).
 - **Next Sequence:** only available if **Cyclic** has been disabled; allows the execution of another sequence after the last step of the current sequence. The options are “No Sequence” and “Sequence ‘n’” (being ‘n’ a value between 1 and 5 for individual / white channels, or between 1 and 10 for RGB / RGBW channels).

Additionally, each individual sequence step offers the following parameters:

- **Action** (only RGB / RGBW channels): sets the action to perform in the current step. Allows choosing between the following options:

“Luminosity”, “Predefined Colour” and “RGB/RGBW Colour”, as explained in section 2.2.6.

- **Value** (only individual or W channels): analogous to choosing “Luminosity” in the previous parameter (**Action**).
- **Dimming Type**: “At Once”, “Dimming Time 1”, “Dimming Time 2”, “Dimming Time 3”, “Equal to Action Time”. The latter makes the dimming length (see section 2.2.1) match the action time configured.
- **Action time**: defines the duration of the action, i.e., the time it will take until the next action begins execution. The available range is 1 to 100 tenths of a second, seconds or minutes.

Note: *in the event of an action time greater than the selected **Dimming Type**, the channel will remain in the same state until this time is over.*

Actions will be run in order (starting from the first one), once Lumento C receives through “[Ch] Scenes/Sequences” the value that triggers the sequence. Moreover, if the sequence is configured as “Cyclic”, once the last action ends, the sequence will be restarted.

An example of custom sequence is shown in Figure 21, where the three first actions have been configured.

GENERAL

- Channel RGBW
 - Configuration
 - Switch On/Off
 - Dimming
 - Status Objects
 - Scenes/Sequences
 - Scene/Sequence 1
 - Scene/Sequence 7

Scene/Sequence Number [1 to 64] 47

Scene/Sequence Type Custom Sequence

Cyclic

Next Sequence Sequence 7

Send Luminosity During the Sequence

Action 1

Action Predefined Color

Color BLUE (Turquoise)

Dimming Type Equal to Action Time

Action Time 10 s

Action 2

Action Luminosity

Luminosity 74 %

Dimming Type Dimming Time 1

Action Time 25 s

Action 3

Action RGBW Color

R 255

G 51

B 15

W 40

Dimming Type At Once

Action Time 10 s

Action 4

Action 5

Figure 21. Custom Sequence

2.2.9 LOCK

Enabling the lock function will bring a **one-bit** object which will allow locking and unlocking the related channel. Channel locking will cause ignoring any bus orders addressing to that channel.

Receiving a lock order while running a sequence, intermittence, temporisation or automatic colour shift **will stop the execution of that action as well as the sending of the status objects**.

ETS PARAMETERISATION

Once this function has been enabled, the following objects will show in ETS:

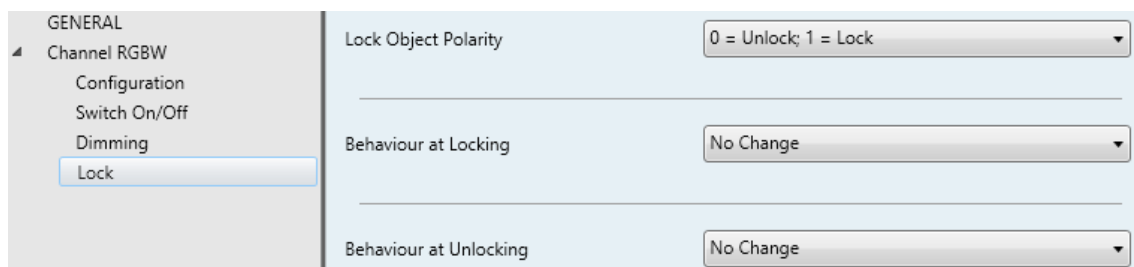

Figure 22. Lock

- **Lock Object Polarity:** sets which value will be interpreted as a locking order and which one as an unlocking order: “0 = Unlock; 1 = Lock” (default) or “0 = Lock; 1 = Unlock”.
- **Behaviour at Locking:** sets the action to be performed when a locking order is received: “No Change” (default option), “Off” (will switch off the channel), “On” (will switch on the channel) or “Fixed Value” (which itself offers the options “Luminosity”, “Predefined Colour” and “RGB/RGBW Colour”, already explained in section 2.2.6).
- **Behaviour at Unlocking:** sets the action to be performed when an unlocking order is received. The options are analogous to those for the behaviour at locking, but will comprise another one: “Previous State Before Locking” (to recover the status previous to the locking order).

2.2.10 CUSTOM INITIALISATION

This function permits customising the initial state of the channel at the start-up of the device.

Opting for the **default initial configuration** implies the following:

- After an ETS download, the channel will remain off.
- After recovering from a bus power failure, the channel will recover the state previous to the power failure.

On the other hand, opting for a **custom initial configuration** allows parameterising the desired channel state after the bus power is restored or after a download.

Note: *bus failures do not switch off LED loads, unless the external power is interrupted as well.*

ETS PARAMETERISATION

Once the option to customise the initial configuration has been enabled in the “General” window (otherwise, the default configuration will be applied), the following objects will show in ETS:

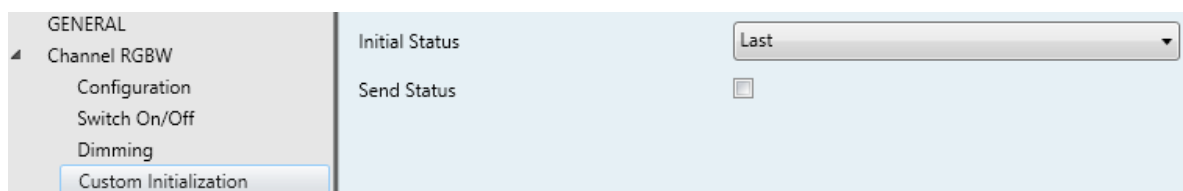

Figure 23. Custom initialisation

Selecting this tab will allow setting up the following features and parameters:

- **Initial Status:** sets the desired initial state of the channel:
 - “Last” (default value): when the bus power is restored, the channel will recover the illumination state previous to the bus failure. Note that this option has no effect after a download (the channel will remain off).
 - “Off”: the channel will always start off.

- **“Fixed Value”**: the channel will start with a specific configuration: **“Luminosity”**, **“Predefined Colour”** and **“RGB/RGBW Colour”**, as explained in section 2.2.6.
- **Send Status**: if enabled, the status objects will be sent to the bus at the start-up of Lumento C, thus informing other devices about the initial state of the channel. This requires that the status objects have been enabled in parameters (see section 2.2.2).
- **Delay**: sets the time (in seconds) that Lumento C will wait before performing this sending.

Note: *in case the initial state of the output does not match the last value sent to the bus through the status objects before the reset, an immediate sending will take place at the start-up of the device, no matter if the **Send Status** function (delayed or not) has not been enabled.*

ANNEX I. COMMUNICATION OBJECTS

- “**Functional range**” shows the values that, with independence of any other values permitted by the bus according to the object size, may be of any use or have a particular meaning because of the specifications or restrictions from both the KNX standard or the application programme itself.

Number	Size	I/O	Flags	Data type (DPT)	Functional Range	Name	Function
1	1 Bit	O	C T R - -	DPT_Alarm	0/1	Error: Overheating	0=Normal; 1=Overheat
2	1 Bit	O	C T R - -	DPT_Alarm	0/1	Error: Current Selector Mismatch	0=Match; 1=Mismatch
3	1 Bit	O	C T R - -	DPT_Alarm	0/1	Error: External Voltage	0=Normal; 1=Low Ext. Voltage
4	1 Bit	I	C - - W -	DPT_Switch	0/1	[RGBW] Switch On/Off	0=Off; 1=On
	1 Bit	I	C - - W -	DPT_Switch	0/1	[RGB] Switch On/Off	0=Off; 1=On
5	4 Bit	I	C - - W -	DPT_Control_Dimming	0x0 (Stop) 0x1 (Dec. by 100%) ... 0x7 (Dec. by 1%) 0x8 (Stop) 0x9 (Inc. by 100%) ... 0xF (Inc. by 1%)	[RGBW] Relative Dimming	4-bits Dimmer Control
	4 Bit	I	C - - W -	DPT_Control_Dimming	0x0 (Stop) 0x1 (Dec. by 100%) ... 0x7 (Dec. by 1%) 0x8 (Stop) 0x9 (Inc. by 100%) ... 0xF (Inc. by 1%)	[RGB] Relative Dimming	4-bits Dimmer Control
6	1 Byte	I	C - - W -	DPT_Scaling	0% - 100%	[RGBW] Absolute Dimming	1-byte Dimmer Control
	1 Byte	I	C - - W -	DPT_Scaling	0% - 100%	[RGB] Absolute Dimming	1-byte Dimmer Control
7-9	2 Bytes	I	C - - W -	DPT_TimePeriodSec	0-65535	[RGBW] Dimming Time X	Time in seconds
	2 Bytes	I	C - - W -	DPT_TimePeriodSec	0-65535	[RGB] Dimming Time X	Time in seconds
10	3 Bytes	I	C - - W -	DPT_Colour_RGB	[0 - 255] * 3	[RGBW] RGB Color	3-bytes RGB Control
	3 Bytes	I	C - - W -	DPT_Colour_RGB	[0 - 255] * 3	[RGB] RGB Color	3-bytes RGB Control
11	1 Byte	I	C - - W -	DPT_SceneControl	0-63; 128-191	[RGBW] Direct Color	Color number (Scene 1-22)
	1 Byte	I	C - - W -	DPT_SceneControl	0-63; 128-191	[RGB] Direct Color	Color number (Scene 1-22)

12	1 Bit	I	C - - W -	DPT_Start	0/1	[RGBW] Color Shift	0=Stop; 1=Start
	1 Bit	I	C - - W -	DPT_Start	0/1	[RGB] Color Shift	0=Stop; 1=Start
13	4 Bit	I	C - - W -	DPT_Control_Dimming	0x0 (Stop) 0x1 (Dec. by 100%) ... 0x7 (Dec. by 1%) 0x8 (Stop) 0x9 (Inc. by 100%) ... 0xF (Inc. by 1%)	[RGBW] Color Shift	4-bits Color Control
	4 Bit	I	C - - W -	DPT_Control_Dimming	0x0 (Stop) 0x1 (Dec. by 100%) ... 0x7 (Dec. by 1%) 0x8 (Stop) 0x9 (Inc. by 100%) ... 0xF (Inc. by 1%)	[RGB] Color Shift	4-bits Color Control
14	1 Bit	I	C - - W -	DPT_Start	0/1	[RGBW] Simple Timer	0=Deactivate; 1=Activate
	1 Bit	I	C - - W -	DPT_Start	0/1	[RGB] Simple Timer	0=Deactivate; 1=Activate
15	1 Bit	I	C - - W -	DPT_Start	0/1	[RGBW] Flashing	0=Deactivate; 1=Activate
	1 Bit	I	C - - W -	DPT_Start	0/1	[RGB] Flashing	0=Deactivate; 1=Activate
16	1 Byte	I	C - - W -	DPT_SceneControl	0-63; 128-191	[RGBW] Scenes/Sequences	Scene/Sequence number
	1 Byte	I	C - - W -	DPT_SceneControl	0-63; 128-191	[RGB] Scenes/Sequences	Scene/Sequence number
17	1 Bit	I	C - - W -	DPT_Start	0/1	[RGBW] Start/Stop Sequence	0=Stop; 1=Start
	1 Bit	I	C - - W -	DPT_Start	0/1	[RGB] Start/Stop Sequence	0=Stop; 1=Start
18-21	1 Bit	I	C - - W -	DPT_Switch	0/1	[RGBW] Custom On/Off X	0=Off; 1=On
	1 Bit	I	C - - W -	DPT_Switch	0/1	[RGB] Custom On/Off X	0=Off; 1=On
22	1 Bit	I	C - - W -	DPT_Enable	0/1	[RGBW] Lock	0=Unlock; 1=Lock
	1 Bit	I	C - - W -	DPT_Enable	0/1	[RGB] Lock	0=Unlock; 1=Lock
	1 Bit	I	C - - W -	DPT_Enable	0/1	[RGBW] Lock	0=Lock; 1=Unlock
	1 Bit	I	C - - W -	DPT_Enable	0/1	[RGB] Lock	0=Lock; 1=Unlock
23	1 Bit	O	C T R - -	DPT_Switch	0/1	[RGBW] On/Off (Status)	0=Off; 1=On
	1 Bit	O	C T R - -	DPT_Switch	0/1	[RGB] On/Off (Status)	0=Off; 1=On
24	1 Byte	O	C T R - -	DPT_Scaling	0% - 100%	[RGBW] Dimming Value (Status)	0 - 100%
	1 Byte	O	C T R - -	DPT_Scaling	0% - 100%	[RGB] Dimming Value (Status)	0 - 100%
25	3 Bytes	O	C T R - -	DPT_Colour_RGB	[0 - 255] * 3	[RGBW] RGB Dimming Values (Status)	3-bytes status
	3 Bytes	O	C T R - -	DPT_Colour_RGB	[0 - 255] * 3	[RGB] RGB Dimming Values (Status)	3-bytes status
26	1 Bit	I	C - - W -	DPT_Switch	0/1	[1] Switch On/Off	0=Off; 1=On
	1 Bit	I	C - - W -	DPT_Switch	0/1	[R] Switch On/Off	0=Off; 1=On

27	4 Bit	I	C - - W -	DPT_Control_Dimming	0x0 (Stop) 0x1 (Dec. by 100%) ... 0x7 (Dec. by 1%) 0x8 (Stop) 0x9 (Inc. by 100%) ... 0xF (Inc. by 1%)	[1] Relative Dimming	4-bits Dimmer Control
	4 Bit	I	C - - W -	DPT_Control_Dimming	0x0 (Stop) 0x1 (Dec. by 100%) ... 0x7 (Dec. by 1%) 0x8 (Stop) 0x9 (Inc. by 100%) ... 0xF (Inc. by 1%)	[R] Relative Dimming	4-bits Dimmer Control
28	1 Byte	I	C - - W -	DPT_Scaling	0% - 100%	[1] Absolute Dimming	1-byte Dimmer Control
	1 Byte	I	C - - W -	DPT_Scaling	0% - 100%	[R] Absolute Dimming	1-byte Dimmer Control
29-31	2 Bytes	I	C - - W -	DPT_TimePeriodSec	0-65535	[1] Dimming Time X	Time in seconds
32	1 Bit	I	C - - W -	DPT_Start	0/1	[1] Simple Timer	0=Deactivate; 1=Activate
33	1 Bit	I	C - - W -	DPT_Start	0/1	[1] Flashing	0=Deactivate; 1=Activate
34	1 Byte	I	C - - W -	DPT_SceneControl	0-63; 128-191	[1] Scenes/Sequences	Scene/Sequence number
35	1 Bit	I	C - - W -	DPT_Start	0/1	[1] Start/Stop Sequence	0=Stop; 1=Start
36-39	1 Bit	I	C - - W -	DPT_Switch	0/1	[1] Custom On/Off X	0=Off; 1=On
40	1 Bit	I	C - - W -	DPT_Enable	0/1	[1] Lock	0=Unlock; 1=Lock
	1 Bit	I	C - - W -	DPT_Enable	0/1	[1] Lock	0=Lock; 1=Unlock
41	1 Bit	O	C T R - -	DPT_Switch	0/1	[1] On/Off (Status)	0=Off; 1=On
	1 Bit	O	C T R - -	DPT_Switch	0/1	[R] On/Off (Status)	0=Off; 1=On
42	1 Byte	O	C T R - -	DPT_Scaling	0% - 100%	[1] Dimming Value (Status)	0 - 100%
	1 Byte	O	C T R - -	DPT_Scaling	0% - 100%	[R] Dimming Value (Status)	0 - 100%
43	1 Bit	I	C - - W -	DPT_Switch	0/1	[2] Switch On/Off	0=Off; 1=On
	1 Bit	I	C - - W -	DPT_Switch	0/1	[G] Switch On/Off	0=Off; 1=On
44	4 Bit	I	C - - W -	DPT_Control_Dimming	0x0 (Stop) 0x1 (Dec. by 100%) ... 0x7 (Dec. by 1%) 0x8 (Stop) 0x9 (Inc. by 100%) ... 0xF (Inc. by 1%)	[2] Relative Dimming	4-bits Dimmer Control
	4 Bit	I	C - - W -	DPT_Control_Dimming	0x0 (Stop)	[G] Relative Dimming	4-bits Dimmer Control

					0x1 (Dec. by 100%) ... 0x7 (Dec. by 1%) 0x8 (Stop) 0x9 (Inc. by 100%) ... 0xF (Inc. by 1%)		
45	1 Byte	I	C - - W -	DPT_Scaling	0% - 100%	[2] Absolute Dimming	1-byte Dimmer Control
	1 Byte	I	C - - W -	DPT_Scaling	0% - 100%	[G] Absolute Dimming	1-byte Dimmer Control
46-48	2 Bytes	I	C - - W -	DPT_TimePeriodSec	0-65535	[2] Dimming Time X	Time in seconds
49	1 Bit	I	C - - W -	DPT_Start	0/1	[2] Simple Timer	0=Deactivate; 1=Activate
50	1 Bit	I	C - - W -	DPT_Start	0/1	[2] Flashing	0=Deactivate; 1=Activate
51	1 Byte	I	C - - W -	DPT_SceneControl	0-63; 128-191	[2] Scenes/Sequences	Scene/Sequence number
52	1 Bit	I	C - - W -	DPT_Start	0/1	[2] Start/Stop Sequence	0=Stop; 1=Start
53-56	1 Bit	I	C - - W -	DPT_Switch	0/1	[2] Custom On/Off X	0=Off; 1=On
57	1 Bit	I	C - - W -	DPT_Enable	0/1	[2] Lock	0=Unlock; 1=Lock
	1 Bit	I	C - - W -	DPT_Enable	0/1	[2] Lock	0=Lock; 1=Unlock
58	1 Bit	O	C T R - -	DPT_Switch	0/1	[2] On/Off (Status)	0=Off; 1=On
	1 Bit	O	C T R - -	DPT_Switch	0/1	[G] On/Off (Status)	0=Off; 1=On
59	1 Byte	O	C T R - -	DPT_Scaling	0% - 100%	[2] Dimming Value (Status)	0 - 100%
	1 Byte	O	C T R - -	DPT_Scaling	0% - 100%	[G] Dimming Value (Status)	0 - 100%
60	1 Bit	I	C - - W -	DPT_Switch	0/1	[3] Switch On/Off	0=Off; 1=On
	1 Bit	I	C - - W -	DPT_Switch	0/1	[B] Switch On/Off	0=Off; 1=On
61	4 Bit	I	C - - W -	DPT_Control_Dimming	0x0 (Stop) 0x1 (Dec. by 100%) ... 0x7 (Dec. by 1%) 0x8 (Stop) 0x9 (Inc. by 100%) ... 0xF (Inc. by 1%)	[3] Relative Dimming	4-bits Dimmer Control
	4 Bit	I	C - - W -	DPT_Control_Dimming	0x0 (Stop) 0x1 (Dec. by 100%) ... 0x7 (Dec. by 1%) 0x8 (Stop) 0x9 (Inc. by 100%) ... 0xF (Inc. by 1%)	[B] Relative Dimming	4-bits Dimmer Control
62	1 Byte	I	C - - W -	DPT_Scaling	0% - 100%	[3] Absolute Dimming	1-byte Dimmer Control
	1 Byte	I	C - - W -	DPT_Scaling	0% - 100%	[B] Absolute Dimming	1-byte Dimmer Control

63-65	2 Bytes	I	C - - W -	DPT_TimePeriodSec	0-65535	[3] Dimming Time X	Time in seconds
66	1 Bit	I	C - - W -	DPT_Start	0/1	[3] Simple Timer	0=Deactivate; 1=Activate
67	1 Bit	I	C - - W -	DPT_Start	0/1	[3] Flashing	0=Deactivate; 1=Activate
68	1 Byte	I	C - - W -	DPT_SceneControl	0-63; 128-191	[3] Scenes/Sequences	Scene/Sequence number
69	1 Bit	I	C - - W -	DPT_Start	0/1	[3] Start/Stop Sequence	0=Stop; 1=Start
70-73	1 Bit	I	C - - W -	DPT_Switch	0/1	[3] Custom On/Off X	0=Off; 1=On
74	1 Bit	I	C - - W -	DPT_Enable	0/1	[3] Lock	0=Unlock; 1=Lock
	1 Bit	I	C - - W -	DPT_Enable	0/1	[3] Lock	0=Lock; 1=Unlock
75	1 Bit	O	C T R - -	DPT_Switch	0/1	[3] On/Off (Status)	0=Off; 1=On
	1 Bit	O	C T R - -	DPT_Switch	0/1	[B] On/Off (Status)	0=Off; 1=On
76	1 Byte	O	C T R - -	DPT_Scaling	0% - 100%	[3] Dimming Value (Status)	0 - 100%
	1 Byte	O	C T R - -	DPT_Scaling	0% - 100%	[B] Dimming Value (Status)	0 - 100%
77	1 Bit	I	C - - W -	DPT_Switch	0/1	[4] Switch On/Off	0=Off; 1=On
	1 Bit	I	C - - W -	DPT_Switch	0/1	[W] Switch On/Off	0=Off; 1=On
78	4 Bit	I	C - - W -	DPT_Control_Dimming	0x0 (Stop) 0x1 (Dec. by 100%) ... 0x7 (Dec. by 1%) 0x8 (Stop) 0x9 (Inc. by 100%) ... 0xF (Inc. by 1%)	[4] Relative Dimming	4-bits Dimmer Control
	4 Bit	I	C - - W -	DPT_Control_Dimming	0x0 (Stop) 0x1 (Dec. by 100%) ... 0x7 (Dec. by 1%) 0x8 (Stop) 0x9 (Inc. by 100%) ... 0xF (Inc. by 1%)	[W] Relative Dimming	4-bits Dimmer Control
79	1 Byte	I	C - - W -	DPT_Scaling	0% - 100%	[4] Absolute Dimming	1-byte Dimmer Control
	1 Byte	I	C - - W -	DPT_Scaling	0% - 100%	[W] Absolute Dimming	1-byte Dimmer Control
80-82	2 Bytes	I	C - - W -	DPT_TimePeriodSec	0-65535	[4] Dimming Time X	Time in seconds
	2 Bytes	I	C - - W -	DPT_TimePeriodSec	0-65535	[W] Dimming Time X	Time in seconds
83	1 Bit	I	C - - W -	DPT_Start	0/1	[4] Simple Timer	0=Deactivate; 1=Activate
	1 Bit	I	C - - W -	DPT_Start	0/1	[W] Simple Timer	0=Deactivate; 1=Activate
84	1 Bit	I	C - - W -	DPT_Start	0/1	[4] Flashing	0=Deactivate; 1=Activate
	1 Bit	I	C - - W -	DPT_Start	0/1	[W] Flashing	0=Deactivate; 1=Activate
85	1 Byte	I	C - - W -	DPT_SceneControl	0-63; 128-191	[4] Scenes/Sequences	Scene/Sequence number
	1 Byte	I	C - - W -	DPT_SceneControl	0-63; 128-191	[W] Scenes/Sequences	Scene/Sequence number

86	1 Bit	I	C - - W -	DPT_Start	0/1	[4] Start/Stop Sequence	0=Stop; 1=Start
	1 Bit	I	C - - W -	DPT_Start	0/1	[W] Start/Stop Sequence	0=Stop; 1=Start
87-90	1 Bit	I	C - - W -	DPT_Switch	0/1	[4] Custom On/Off X	0=Off; 1=On
	1 Bit	I	C - - W -	DPT_Switch	0/1	[W] Custom On/Off X	0=Off; 1=On
91	1 Bit	I	C - - W -	DPT_Enable	0/1	[4] Lock	0=Unlock; 1=Lock
	1 Bit	I	C - - W -	DPT_Enable	0/1	[W] Lock	0=Unlock; 1=Lock
	1 Bit	I	C - - W -	DPT_Enable	0/1	[4] Lock	0=Lock; 1=Unlock
	1 Bit	I	C - - W -	DPT_Enable	0/1	[W] Lock	0=Lock; 1=Unlock
92	1 Bit	O	C T R - -	DPT_Switch	0/1	[4] On/Off (Status)	0=Off; 1=On
	1 Bit	O	C T R - -	DPT_Switch	0/1	[W] On/Off (Status)	0=Off; 1=On
93	1 Byte	O	C T R - -	DPT_Scaling	0% - 100%	[4] Dimming Value (Status)	0 - 100%
	1 Byte	O	C T R - -	DPT_Scaling	0% - 100%	[W] Dimming Value (Status)	0 - 100%

Zennio Avance y Tecnología S.L.
C/ Río Jarama, 132. Nave P-8.11
45007 Toledo (Spain).

Tel. +34 925 232 002

*www.zennio.com
info@zennio.com*



RoHS