

Colour
is our nature

Connecting and configuring the POWERdrive 45D/90D/180D

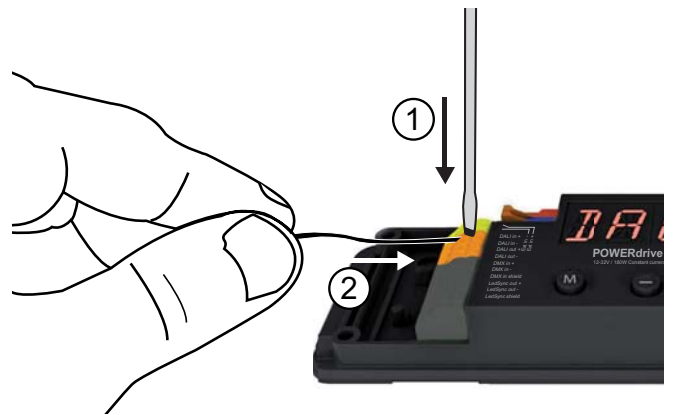

A Removing the cover



E Optional: Connecting external control device or network cabling



B Removing the strain reliefs

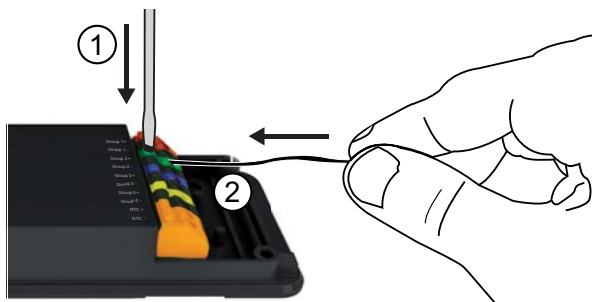

C Connecting LED wires



F Fastening the strain reliefs

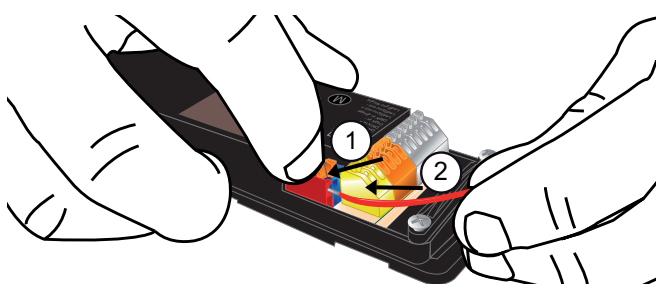

D Connecting power supply wires



G Configuring the POWERdrive

Manual configuration

1. Select mode of operation:

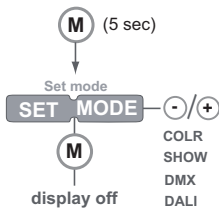

2. Set LED current and LED groups:

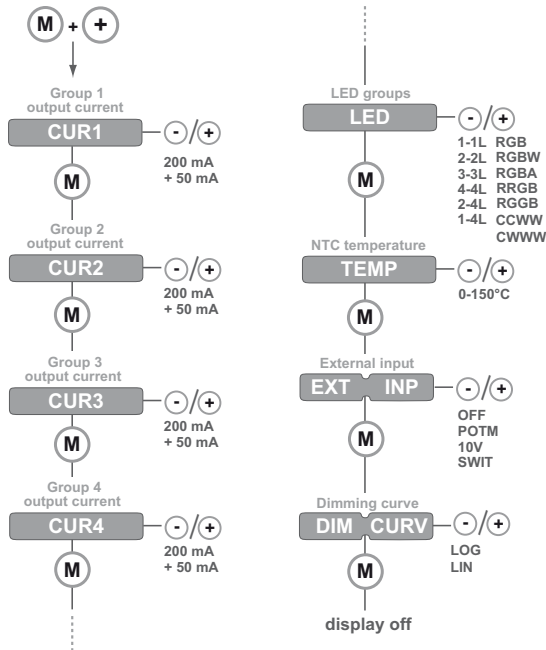

3. Standalone operation - Colour*

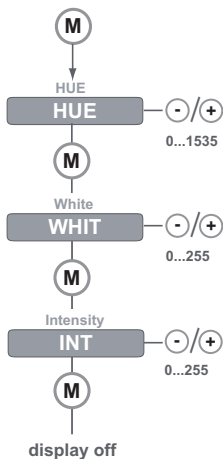

or

Standalone operation - Show -

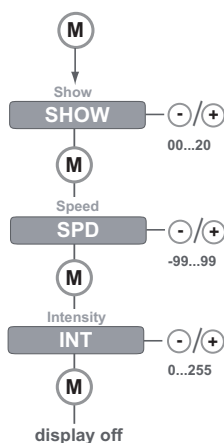

or

Networked operation - DMX or DALI -

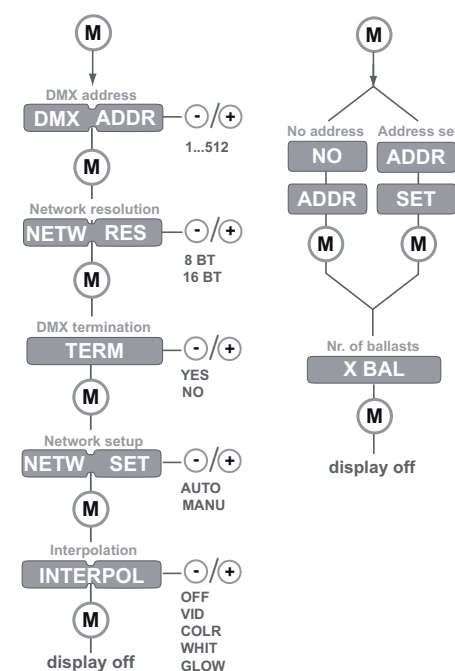

* The colour menu depends on the LED group settings you have selected in step 2.

Other features

Locking the configuration

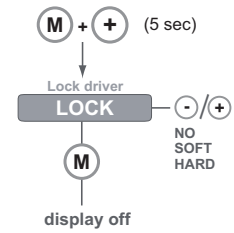

Visual test run

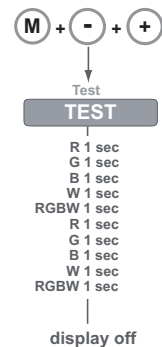

Reset to factory defaults

